



McIntosh Laboratory, Inc. 2 Chambers Street Binghamton, New York 13903-2699 Phone: 607-723-3512 [www.mcintoshlabs.com](http://www.mcintoshlabs.com)

MA5200  
Integrated Amplifier  
Owner's Manual



The lightning flash with arrowhead, within an equilateral triangle, is intended to alert the user to the presence of uninsulated “dangerous voltage” within the product’s enclosure that may be of sufficient magnitude to constitute a risk of electric shock to persons.

**WARNING - TO REDUCE RISK OF FIRE OR ELECTRICAL SHOCK, DO NOT EXPOSE THIS EQUIPMENT TO RAIN OR MOISTURE.**

## IMPORTANT SAFETY INSTRUCTIONS!

### PLEASE READ THEM BEFORE OPERATING THIS EQUIPMENT.

1. Read these instructions.
2. Keep these instructions.
3. Heed all warnings.
4. Follow all instructions.
5. Do not use this apparatus near water.
6. Clean only with a dry cloth.
7. Do not block any ventilation openings. Install in accordance with the manufacturer’s instructions.
8. Do not install near any heat sources such as radiators, heat registers, stoves, or other apparatus (including amplifiers) that produce heat.
9. Do not defeat the safety purpose of the polarized or grounding-type plug. A polarized plug has two blades with one wider than the other. A grounding type plug has two blades and a



**AVIS** RISQUE DE CHOC ELECTRIQUE - NE PAS OUVRIR.

**NO USER-SERVICEABLE PARTS INSIDE. REFER SERVICING TO QUALIFIED PERSONNEL.**

third grounding prong. The wide blade or the third prong are provided for your safety. If the provided plug does not fit into your outlet, consult an electrician for replacement of the obsolete outlet.

10. Protect the power cord from being walked on or pinched particularly at plugs, convenience receptacles, and the point where they exit from the apparatus.
11. Only use attachments/accessories specified by the manufacturer.
12. Use only with the cart, stand, tripod, bracket, or table specified by the manufacturer, or sold with the apparatus. When a cart is used, use caution when moving the cart/apparatus combination to avoid injury from tip-over.
13. Unplug this apparatus during lightning storms or when unused for long periods of time.
14. Refer all servicing to qualified service personnel. Servicing is required when the apparatus has been damaged in any way, such as power-



The exclamation point within an equilateral triangle is intended to alert the user to the presence of important operating and maintenance (servicing) instructions in the literature accompanying the appliance.

**To prevent the risk of electric shock, do not remove cover or back. No user-serviceable parts inside.**

supply cord or plug is damaged, liquid has been spilled or objects have fallen into the apparatus, the apparatus has been exposed to rain or moisture, does not operate normally, or has been dropped.

15. Do not expose this equipment to dripping or splashing and ensure that no objects filled with liquids, such as vases, are placed on the equipment.
16. To completely disconnect this equipment from the a.c. mains, disconnect the power supply cord plug from the a.c. receptacle.
17. The mains plug of the power supply cord shall remain readily operable.
18. Do not expose batteries to excessive heat such as sunshine, fire or the like.
19. Connect mains power supply cord only to a mains socket outlet with a protective earthing connection.

## Thank You

Your decision to own this McIntosh MA5200 Integrated Amplifier ranks you at the very top among discriminating music listeners. You now have the best. The McIntosh dedication to precision performance assures many years of musical enjoyment. Please take a short time to read the information in this manual. We want you to be as familiar as possible with all the features and functions of your new McIntosh.

## Please Take A Moment

The serial number, purchase date and McIntosh Dealer name are important to you for possible insurance claim or future service. The spaces below have been provided for you to record that information:

Serial Number: \_\_\_\_\_

Purchase Date: \_\_\_\_\_

Dealer Name: \_\_\_\_\_

## Technical Assistance

If at any time you have questions about your McIntosh product, contact your McIntosh Dealer who is familiar with your McIntosh equipment and any other brands that may be part of your system. If you or your Dealer wish additional help concerning a suspected problem, you can receive technical assistance for all McIntosh products at:

McIntosh Laboratory, Inc.  
2 Chambers Street  
Binghamton, New York 13903  
Phone: 607-723-3512  
Fax: 607-724-0549

Copyright 2013 © by McIntosh Laboratory, Inc.

## Customer Service

If it is determined that your McIntosh product is in need of repair, you can return it to your Dealer. You can also return it to the McIntosh Laboratory Service Department. For assistance on factory repair return procedure, contact the McIntosh Service Department at:

McIntosh Laboratory, Inc.  
2 Chambers Street  
Binghamton, New York 13903  
Phone: 607-723-3515  
Fax: 607-723-1917

## Table of Contents

Safety Instructions.....	2
Thank You and Please Take a Moment .....	3
Technical Assistance and Customer Service.....	3
Table of Contents .....	3
General Information .....	4
Connector and Cable Information.....	4
Introduction .....	5
Performance Features .....	5
Dimensions .....	6
Installation.....	7

### Connections:

Rear Panel Connections.....	8
Connecting Components .....	9
Connection Diagrams (Separate Sheet).....	<b>Mc2A/2B</b>
Passthru Connections .....	10
Connecting for Bi-Amplification .....	11
Connecting Loudspeakers.....	12-13

### Remote Control and Front Panel:

Remote Control Push-buttons .....	14
How to use the Remote Control.....	15
Front Panel Displays, Controls, Push-button and Jack.....	16

### Setup Mode:

How to Operate the Setup Mode .....	17
Default Settings .....	17
Firmware Version .....	18
Source Input Reassignment .....	18
Source Input Renaming.....	19
Passthru .....	20
Comm Port Baud Rate.....	20
Remote Control Codes .....	20
Power Mode.....	21

### Operation:

How to Operate the MA5200 .....	22
Power On/Off .....	22
Source Selection .....	22
Volume Control .....	22

### Trim Functions:

Balance.....	22
Trim Level.....	23
Output Mode .....	23
Mono/Stereo Mode .....	23
Display Brightness.....	24
Digital Audio Display .....	24
Meter Backlight .....	24
Trim, Mute, Headphone Jack .....	25
Power Output Meters and Power Guard.....	25
Using a Separate Power Amplifier.....	25
Passthru .....	25-26
Optical and Coaxial Digital Inputs .....	26
USB Input Operation with a Computer.....	26
Reset of Microprocessors .....	26-27
Resetting the MA5200 to default settings.....	27
Photos.....	28-29
Specifications.....	30
Packing Instructions .....	31

## General Information

- For additional connection information, refer to the owner's manual(s) for any component(s) connected to the MA5200.
- Apply AC Power to the MA5200 and other McIntosh Component(s) only after all the system components are connected together. Failure to do so may cause a malfunction of system operations as the Microprocessor's Circuitry inside the components is active when AC Power is applied.
- The MA5200 includes an Auto Off Power Save Feature and the default setting is enabled.** For additional information including how to disable it, refer to page 21.
- The MA5200 Phono MM (Moving Magnet) Input is compatible with high output Moving Coil Phono Cartridges such as the Sumiko Blue Point No.2.
- When Power Amplifier Protection Circuitry of the MA5200 has activated, the Front Panel Power Guard LEDs are illuminated continuously and the sound will be muted.
- When the Power Transformer has overheated due to improper ventilation and/or high ambient operating temperature, AC Power is removed from the MA5200. Normal operation will resume when the operating temperature is in a safe range again.
- For the best performance and safety, it is important to always match the impedance of the Loudspeaker to the Power Amplifier connections. Refer to pages 12 and 13.

*Note: The impedance of a Loudspeaker actually varies as the Loudspeaker reproduces different frequencies. As a result, the nominal impedance rating of the Loudspeaker (usually measured at a midrange frequency) might not always agree with the impedance of the Loudspeaker at low frequencies where the greatest amount of power is required. Contact the Loudspeaker Manufac-*

*turer for additional information about the actual impedance of the Loudspeaker before connecting it to the McIntosh MA5200.*

- The MA5200 Remote Control is capable of operating other components. For additional information go to [www.mcintoshlabs.com](http://www.mcintoshlabs.com).
- The IR Input, with a 1/8 inch mini phone jack, is configured for non-McIntosh IR sensors such as a Xantech Model HL85BK Kit. Use a Connection Block such as a Xantech Model ZC21 when two or more IR sensors need to be connected to the MA5200. The signal from a connected External IR Sensor will have priority over the signal from the Front Panel IR Sensor.
- When discarding the unit, comply with local rules or regulations. Batteries should never be thrown away or incinerated but disposed of in accordance with the local regulations concerning battery disposal.
- For additional information on the MA5200 and other McIntosh Products please visit the McIntosh Web Site at [www.mcintoshlabs.com](http://www.mcintoshlabs.com).



## Connector and Cable Information

### XLR Connectors

Below is the Pin configuration for the XLR Balanced Input Connectors on the MA5200. Refer to the diagram for connection:

- PIN 1: Shield/Ground
- PIN 2: + Output
- PIN 3: - Output

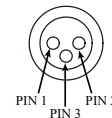

### Power Control Connectors

The Power Control Output Jack sends and Passthru Input Jack receives Power On/Off Signals (+12 volt/0 volt) when connected to other McIntosh Components.

An additional connection is for controlling the illumination of the Power Output Meters on McIntosh Power Amplifiers. A 3.5mm stereo mini phone plug is used for connection to the Power Control and the Passthru jacks.

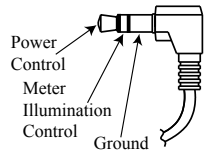

### Data Port Connectors

The Data Out Ports send Remote Control Signals to Source Components. A 3.5mm stereo mini phone plug is used for connection.

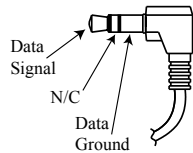

### IR IN Port Connectors

The IR IN Port also uses a 3.5mm stereo mini phone plug and allows the connection of other brand IR Receivers to the MA5200.

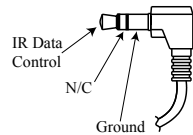

### RS232-C Data Port Cable

The RS232 Data Cable is a 3.5mm stereo mini phone plug to a subminiature DB 9 connector:

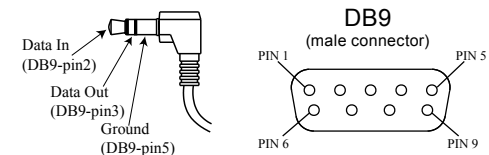

### McIntosh Plug-In Jumper Connector

The MA5200 utilizes a phono style Plug-In Jumper to connect the Preamplifier Output to the Power Amplifier Input, one Jumper for each channel.

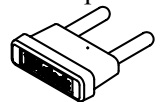

*Note: The Jumper Connector is available from the McIntosh Parts Department:*

**McIntosh Jumper Connector Part No. 117781**

### Introduction

Now you can take advantage of traditional McIntosh standards of excellence in the MA5200 Integrated Amplifier. The Power Amplifier section of the MA5200, with a power output of 100 watts per channel, will drive a pair of quality Loudspeakers to a high level of performance.

The flexible Preamplifier section provides connections for various input sources and may also be used to drive an external Power Amplifier(s).

The MA5200 reproduction is sonically transparent and absolutely accurate. The McIntosh Sound is “The Sound of the Music Itself.”

### Performance Features

#### • Power Output

The MA5200 consists of a 100 watts per channel stereo Power Amplifier with less than 0.005% distortion. The McIntosh MA5200 is designed for connection of a single 8 ohm Loudspeaker per channel. The Power Amplifier uses ThermalTrak<sup>1</sup> Output Transistors for lower distortion and cool operation.

#### • Power Guard

The patented McIntosh Power Guard circuit prevents amplifier clipping and protects your valuable Loudspeakers.

#### • Sentry Monitor and Thermal Protection

McIntosh Sentry Monitor power output stage protection circuits ensure the MA5200 will have a long and trouble free operating life. Built-in Thermal Protection Circuits guard against overheating.

#### • Electronic Switching and Balanced Connections

The Preamplifier uses Logic Circuits controlling Electromagnetic Switches on all inputs and operating functions for reliable, noiseless, distortion free switching. There is a Balanced Input for connection of a source component.

#### • Digital Audio Inputs

The MA5200 has Coaxial, Optical and USB Digital Inputs to decode PCM Signals from an external source. The MA5200 Up Samples the Digital Signal to 192kHz with 32Bit resolution before the Digital to Analog process begins.

#### • Multifunction Fluorescent Display

The Front Panel Display indicates source selection, volume levels and setup functions.

#### • Illuminated Power Meters

The Illuminated Power Output Watt Meters on the MA5200 are peak responding, and indicate the power output of the amplifier.

#### • PassThru Mode

The Automatic PassThru Mode allows the MA5200 to become part of a Multichannel Sound System for DVD-Audio, SACD and Home Theater Movies.

#### • Power Control and Remote Control

The Power Control Output connection provides convenient Turn-On/Off of McIntosh Source Components. The Data Ports together with the supplied Remote Control provide control of McIntosh Source Components connected to the MA5200.

#### • Special Power Supply

The large Power Transformer, multiple filter capacitors with 60 Joules of Energy Storage and regulated Power Supply ensures stable noise free operation even though the power line varies.

#### • McIntosh Custom Binding Posts

McIntosh Patented gold plated output terminals deliver high current output. They accept large diameter wire and spade lugs. Banana plugs may also be used only in the United States and Canada.

#### • Fiber Optic Solid State Front Panel Illumination

The even Illumination of the Front Panel is accomplished by the combination of custom designed Fiber Optic Light Diffusers and extra long life Light Emitting Diodes (LEDs). The glass Front Panel ensures the pristine beauty of the MA5200 will be retained for many years.

<sup>1</sup> ThermalTrak™ and ON Semiconductor are trademarks of Semiconductor Components Industries, LLC

## Dimensions

The following dimensions can assist in determining the best location for your MA5200. There is additional information on the next page pertaining to installing the MA5200 into cabinets.

Front View of the MA5200

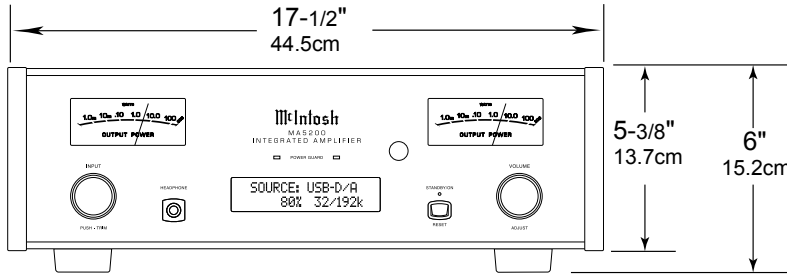

Side View of the MA5200

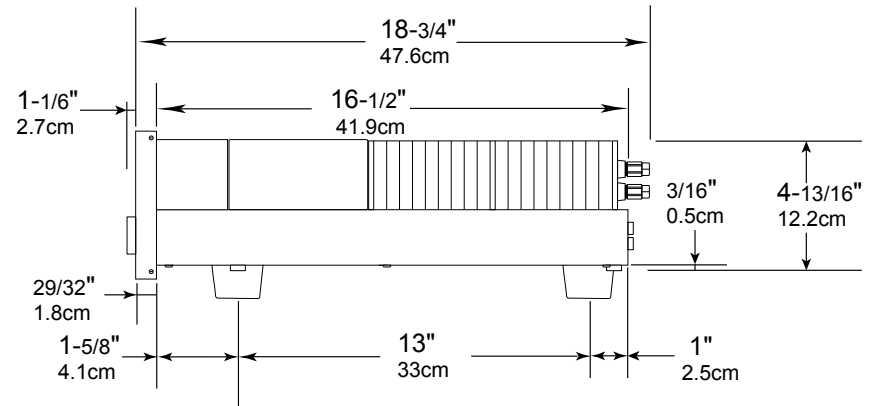

Rear View of the MA5200

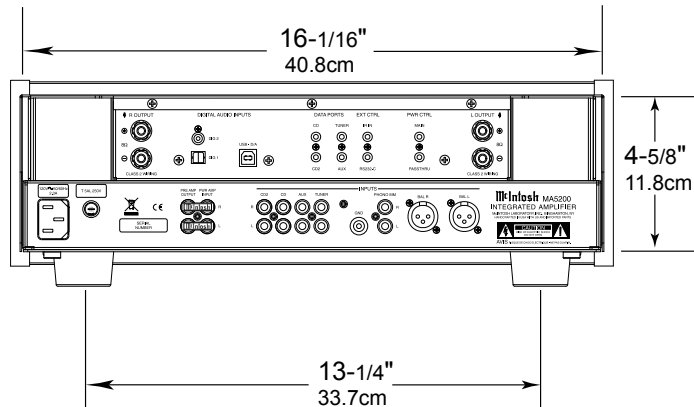

**Installation**

The MA5200 can be placed upright on a table or shelf, standing on its four feet. It also can be custom installed in a piece of furniture or cabinet of your choice. The four feet may be removed from the bottom of the MA5200 when it is custom installed as outlined below. The four feet together with the mounting screws should be retained for possible future use if the MA5200 is removed from the custom installation and used free standing. The required panel cutout, ventilation cutout and unit dimensions are shown.

Always provide adequate ventilation for your MA5200. Cool operation ensures the longest possible operating life for any electronic instrument. Do not install the MA5200 directly above a heat generating component such as a high powered amplifier. If all the components are installed in a single cabinet, a quiet running ventilation fan can be a definite asset in maintaining all the system components at the coolest possible operating temperature.

A custom cabinet installation should provide the following minimum spacing dimensions for cool operation.

Allow at least 6 inches (15.2cm) above the top, 2 inches (5.1cm) below the bottom and 2 inches (5.1cm) on each side of the Integrated Amplifier, so that airflow is not obstructed. Allow 20 inches (50.8cm) depth behind the front panel. Allow 1-1/6 inch (2.7cm) in front of the mounting panel for knob clearance. Be sure to cut out a ventilation hole in the mounting shelf according to the dimensions in the drawing.

**MA5200 Front Panel  
Custom Cabinet Cutout**

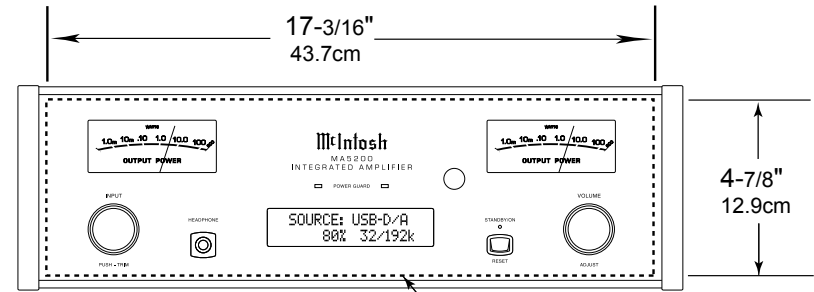

**MA5200 Side View  
in Custom Cabinet**

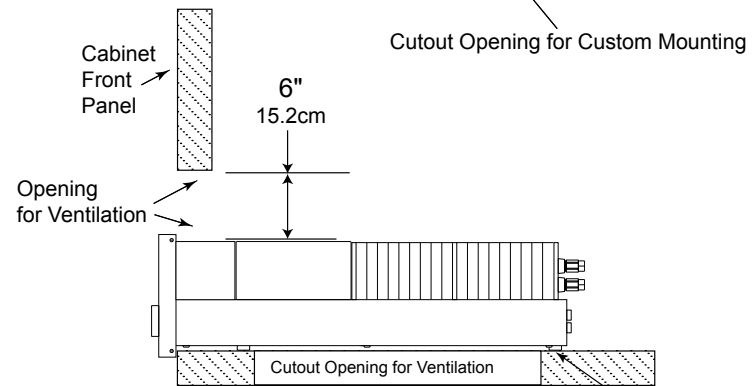

**MA5200 Bottom View  
in Custom Cabinet**

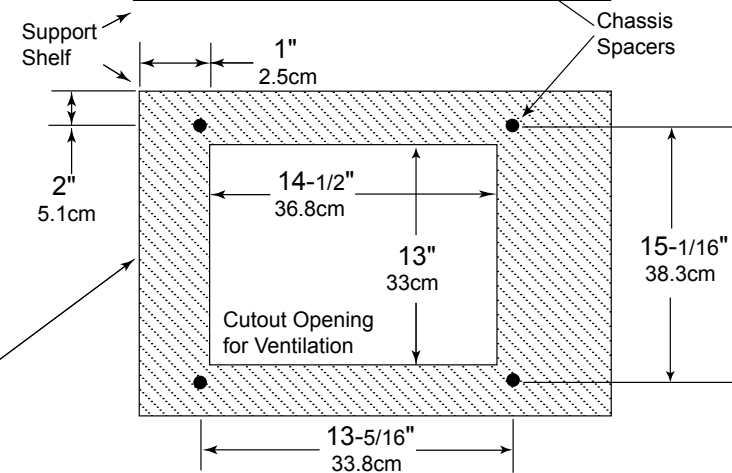

*Note: Center the cutout Horizontally on the unit.  
For purposes of clarity, the above  
illustration is not drawn to scale*

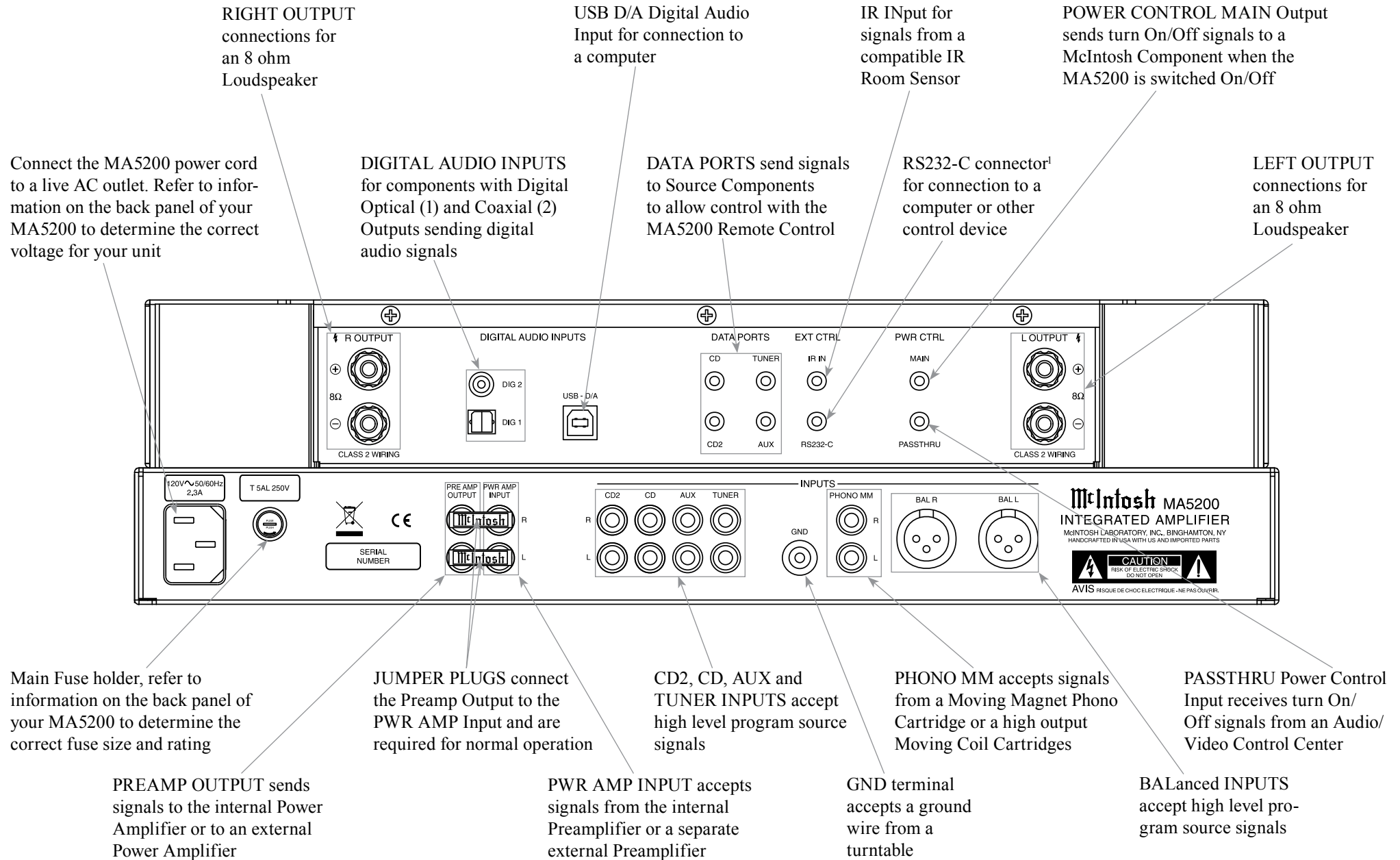

<sup>1</sup> Refer to page 4 for additional cable information.



## Connecting Components

The MA5200 has the ability to automatically switch power On/Off to McIntosh Source Components via the Power Control connection. The Data Port Connections allow for the remote operation of basic functions using the MA5200 Remote Control. With an external sensor connected to the MA5200, remote control operation of the system is possible from another room and/or when the MA5200 is located in a cabinet with the doors closed.

The connection instructions below, together with the MA5200 Input and Output Connection Diagrams located on the separate folded sheet “**Mc2A/2B**”, are an example of a typical audio system. Your system may vary from this, however the actual components would be connected in a similar manner. For additional information refer to “Connector and Cable Information” on page 4.

*Note: Source components may be connected to the MA5200 Balanced Inputs or Digital Inputs instead of Unbalanced Inputs. Refer to Setup “Re-assigning Inputs” to activate them on page 18.*

### **Power Control Connections:**

1. Connect a Control Cable from the MA5200 PWR CTRL (Power Control) MAIN Jack to the Power Control In on the Turntable.
2. Connect a Control Cable from the McIntosh Turntable Power Control Out Jack to the AM/FM Tuner Power Control In Jack.
3. Connect a Control Cable from the AM/FM Tuner Power Control Out Jack to the SACD/CD Player Power Control In Jack.
4. Connect any additional McIntosh Components in a similar manner, as outlined in steps 1 thru 3.

### **Data Control Connections:**

5. Connect a Control Cable from the MA5200 CD DATA PORT Jack to the SACD/CD Player Data In Jack.

6. Connect a Control Cable from the MA5200 TUNER DATA PORT Jack to the AM/FM Tuner Data In Jack.
7. Connect any additional McIntosh Components in a similar manner, as outlined in steps 5 thru 6.

### **Sensor Connection:**

8. Optionally, connect the cable with stereo mini plug coming from the compatible External Sensor to the EXT CTRL (External Control) IR IN Jack on the MA5200. Refer to page 4 “General Information, note 8” for additional information.

### **Audio Connections:**

9. Connect Balanced Cables from the MA5200 BAL (Balanced) L & R Connectors to the SACD/CD Player Fixed Audio Output Balanced Connectors.
10. Connect Audio Cables from the MA5200 TUNER INPUT Jacks to the AM/FM Tuner Output Jacks.
11. Connect the Audio Cables coming from the Turntable to the MA5200 Phono MM Input Jacks for a Moving Magnet Cartridge or high output Moving Coil Cartridge.

*Note: For additional information refer to “General Information” note 4 on page 4.*

12. Connect any additional Components in a similar manner, as outlined in steps 9 thru 11.

### **Optional Digital Audio Connections:**

13. Connect an Optical Cable from the MA5200 DIG (Digital) 2 Digital Audio Input connector to the Digital Audio Out Optical Connector on the SACD/CD Player.

### **Optional USB Connection:**

14. Connect a USB cable with (type A to type B) connectors from the MA5200 USB D/A Digital Audio Input to an available USB connector.

### **Ground Connections:**

15. Connect the Ground Cable coming from the Turntable to the MA5200 GND Binding Post.

*Notes: 1. If the MA5200 is part of a Home Theater System, proceed to “PassThru” connection on page 10.*  
*2. When the MA5200 will be used together with a separate Power Amplifier for Bi-Amplification of a Loudspeaker System, proceed to page 11.*

## Passthru Connections

The MA5200 can be part of a Multichannel Sound System for SACD, DVD-Audio and Home Theater. The Right and Left Front Channels from an Audio/Video Control Center can “Passthru” the MA5200. In the following example the AUX Input will become the “Passthru” input:

1. Connect Audio Cables from the A/V Control Center Front Left and Right Channel Outputs to the MA5200 AUX Input Left and Right Jacks.
2. Connect a Control Cable from the A/V Control Center ZA (Zone A) PC (Power Control) Output to the MA5200 PWR CTRL (Power Control) PASSTRU Input Jack.

*Note: Refer to Setup “Passthru” on page 20 to assign the AUX Input as the “Passthru” Input.*

3. Proceed to “Connecting Loudspeaker” on Page 12.

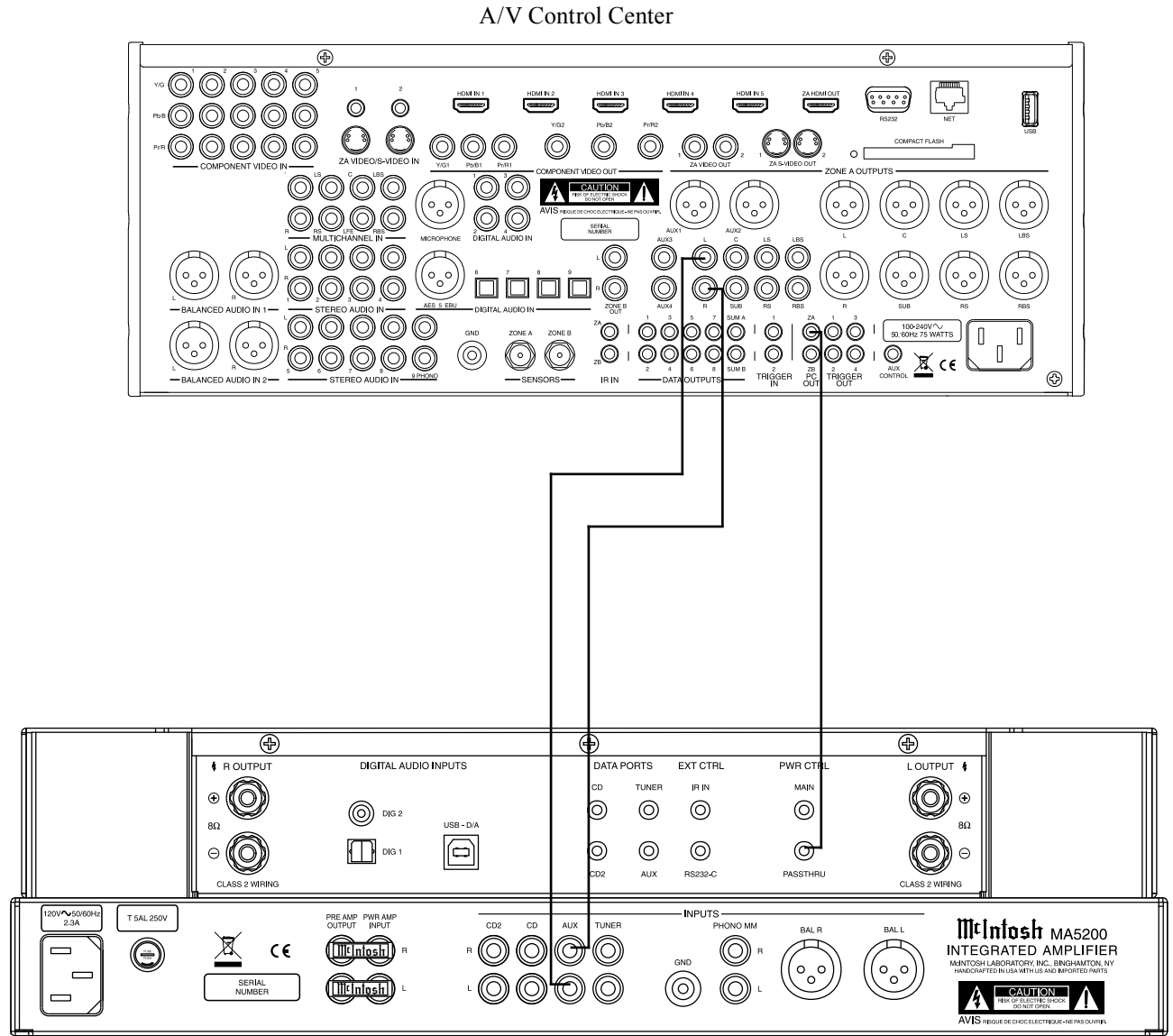

## Connecting for Bi-Amplification

The MA5200's Power Amplifier, together with an additional separate Power Amplifier, may be used to Bi-Amplify a Loudspeaker System. In the illustration on this page the Power Amplifier of the MA5200 is connected to the Midrange/High Frequency Section of the Loudspeaker. The additional separate Power Amplifier is connected to the Low Frequency Section of the Loudspeaker System.

**Warning:** *The Loudspeaker System used for Bi-Amplification must have the jumpers removed from between the MID/HIGH and LOW Frequency Sections of the Loudspeaker System. Failure to remove them could result in damage to the MA5200 and/or the separate Power Amplifier.*

### MA5200 Connections:

1. Remove the "McIntosh Jumpers" from between the PRE AMP OUTPUT Jacks and the PWR AMP INPUT Jacks located on the Rear Panel of the MA5200.

*Note: Place the "McIntosh Jumper" in a safe place for possible future use.*

2. Using a pair of shielded RCA Type Audio "Y" Adapters connect the PRE AMP OUTPUT Jacks to the PWR AMP INPUT Jacks, for both Left and Right Channels.
3. Connect the remaining unconnected part of the "Y" Adapters to the separate Power Amplifier.
4. Referring to the Loudspeaker Connection Instructions on page 12, and in the Owner's Manual supplied with the Power Amplifier and Loudspeaker, connect the MA5200 Output Terminals to the Loudspeaker MID/HIGH Input Terminals.

*Note: The Loudspeaker Connection illustrations on this page are for the Left Channel. Connect the Right Channel Loudspeaker in the same manner.*

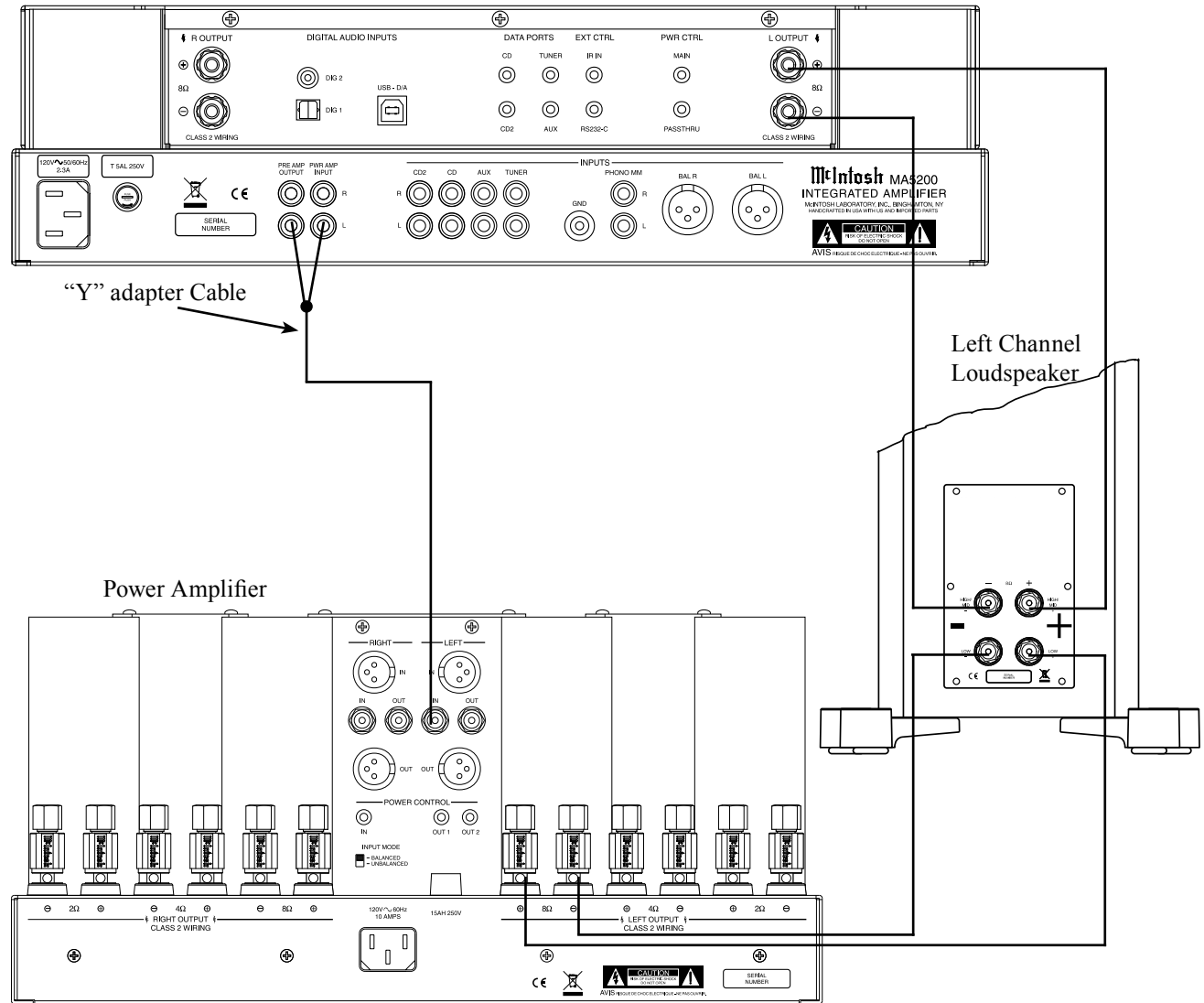

## Output Terminals

When connecting the Loudspeaker Hookup Cables to the MA5200 Amplifier Output Terminals please follow the steps below:

1. Rotate the top of the Output Terminal Post counterclockwise until an opening appears. Refer to figures A and B.
2. Insert the Loudspeaker hookup cable into the Output Terminal Post opening or the cable spade lug around the center post of the Output Terminal. Refer to figure C.
3. Rotate the top of the Output Terminal Post clockwise until it is finger tight. Refer to figure D.
4. Place the supplied McIntosh Wrench over the top of the Output Terminal and rotate it one quarter of a turn (90°) to secure the Loudspeaker Cable Connection. **Do not over tighten.** Refer to figure E.

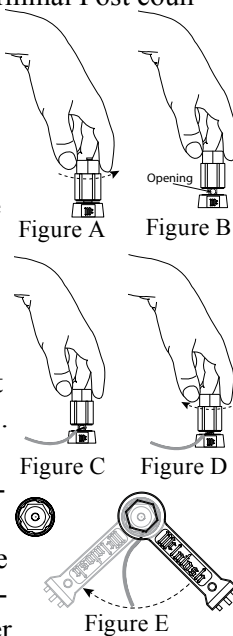

## How to Connect Loudspeakers

**Caution:** Do not connect the AC Power Cord to the MA5200 Rear Panel until after the Loudspeaker Connections are made. Failure to observe this could result in Electric Shock.

The connection instructions below, together with the MA5200 Connection Diagram located on the separate folded sheet “Mc2B”, is an example of a typical audio system. Your system may vary from this, however the actual components would be connected in a similar manner. For additional information refer to “Connector and Cable Information” on page 4.

The McIntosh MA5200 Power Amplifier Circuitry is designed for a Loudspeakers with an impedance of 8 ohms. Connect a single Loudspeaker only to the Right and Left Output Terminals.

When connecting Loudspeakers to the MA5200 it is very important to use cables of adequate size, so there is little to no power loss in the cables. The size is specified in Gauge Numbers or AWG (American Wire Gauge). The smaller the Gauge number, the larger the wire size:

Loudspeaker Cable Distance vs Wire Gauge Guide			
Loudspeaker Impedance	25 feet (7.62 meters) or less	50 feet (15.24 meters) or less	100 feet (30.48 meters) or less
2 Ohms	12AWG	10AWG	8AWG
4 Ohms	14AWG	12AWG	10AWG
8 Ohms	16AWG	14AWG	12AWG

1. Prepare the Loudspeaker Hookup Cable for attachment to the MA5200 Power Amplifier:

### Bare wire cable ends:

Carefully remove sufficient insulation from the cable ends, refer to figures F, G & H. If the cable is stranded, carefully twist the strands together as tightly as possible.

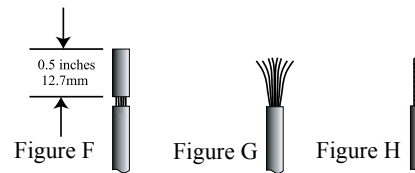

- Notes:
1. If desired, the twisted ends can be tinned with solder to keep the strands together.
  2. The prepared bare wire cable ends may be inserted into spade lug connectors.
  3. Banana plugs are for use in the United States and Canada only.

## Banana Plugs are for use in the United States and Canada only:

2. Attach the previously prepared bare wire cable ends into the banana plugs and secure the connections. Refer to figure I.
3. Rotate the Output Terminal Post clockwise until it is finger tight. Refer to figure J. Then using the McIntosh Wrench, rotate the top of the Output Terminal one quarter of a turn (90°). **Do not over tighten.** Refer to figure E.
4. Referring to figure K, connect the Loudspeaker hookup cables with banana plugs into the hole at the top of the terminal to the MA5200 Negative Output Terminal and Positive Output Terminal to the Loudspeaker Terminal Connections being careful to observe the correct polarities.

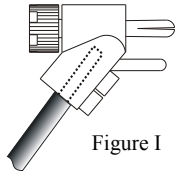

Figure I

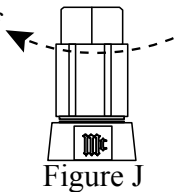

Figure J

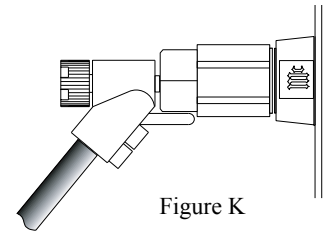

Figure K

*Note: The illustration located on the separate folded sheet “Mc2B” is for connection to an 8Ω (ohms) Loudspeaker.*

Refer to “General Information” Note 6 on page 4 for additional information.

**WARNING:** Loudspeaker terminals are hazardous live and present a risk of electric shock. For additional instruction on making Loudspeaker Connections contact your McIntosh Dealer or McIntosh Technical Support.

5. Connect the MA5200 power cord to an active AC outlet.

## Spade Lug or Wire Connections:

6. Connect the Loudspeaker hookup cables to the MA5200 Negative Output Terminal and Positive Output Terminal to the Loudspeaker Terminal Connections being careful to observe the correct polarities. Insert the spade lug connector or prepared section of the cable end into the terminal side access hole, and tighten the terminal cap until the cable is firmly clamped into the terminals so the lugs or wire cannot slip out. Refer to figures L and M.

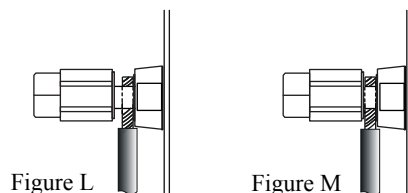

*Note: The illustration located on the separate folded sheet "Mc2B" is for connection to an 8Ω (ohms) Loudspeaker.*

Refer to "General Information" Note 6 on page 4 for additional information.

**WARNING: Loudspeaker terminals are hazardous live and present a risk of electric shock. For additional instruction on making Loudspeaker Connections contact your McIntosh Dealer or McIntosh Technical Support.**

7. Connect the MA5200 power cord to an active AC outlet.



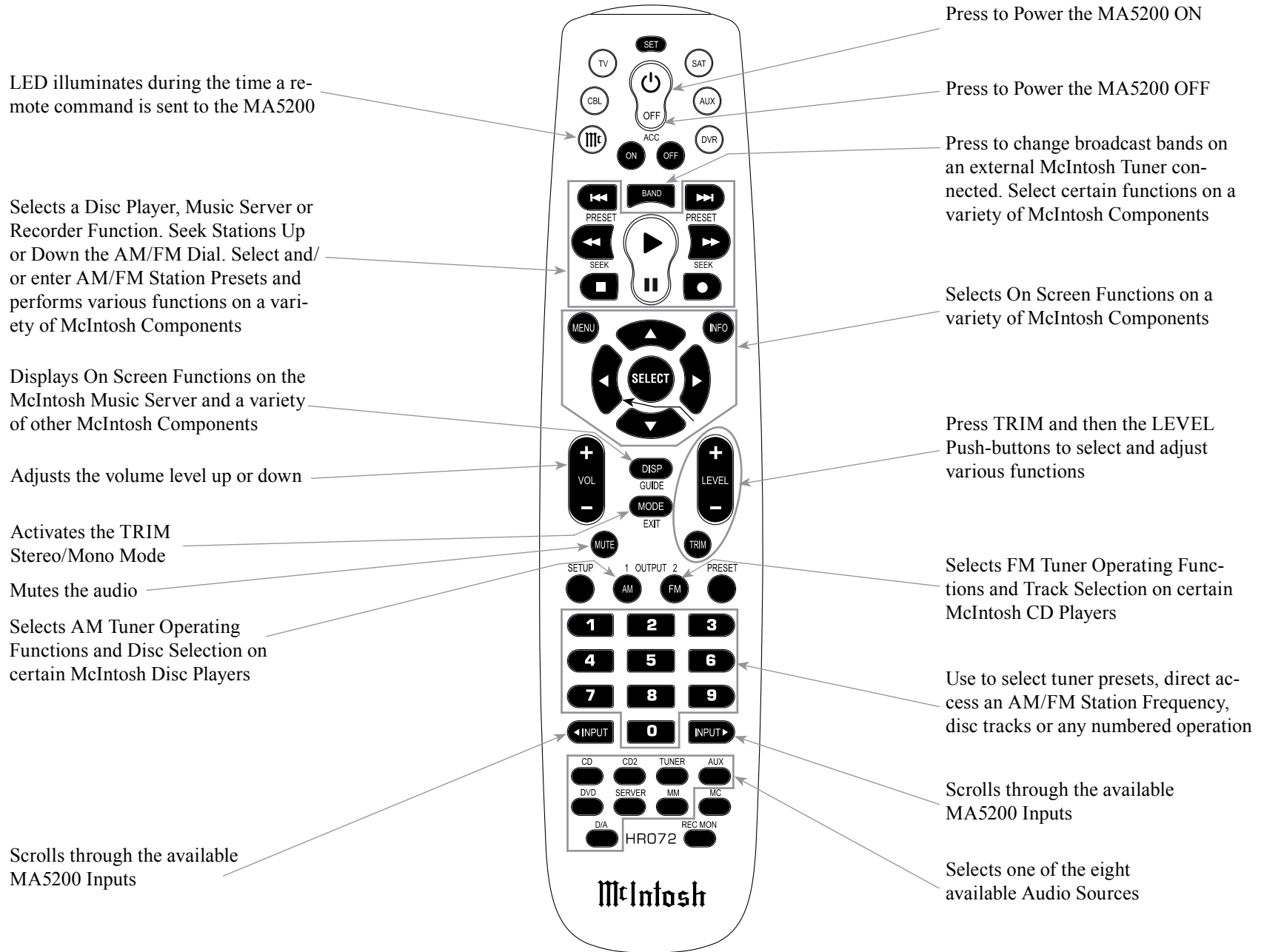

Note: Push-buttons whose function is not identified above are for use with other McIntosh Products.

## How to use the Remote Control

The supplied HR072 Remote Control is capable of directly controlling the functions of contemporary Source Components connected to the MA5200 via the Data Ports.

*Notes: 1. If at any time the MA5200 seems unresponsive to HR072 Remote Control Commands press the  Push-button first.*

*2. For additional information on using the HR072 Remote Control with the MA5200, please refer to the "How to Operate" section of this Owner's Manual starting on page 22.*

### Input Source Selection

Press the appropriate Source Push-button to select the desired program source.

*Note: When the MA5200 is Off, pressing one of the Source Push-buttons will switch the MA5200 On and it will go to that Input.*

### Mute

Press the MUTE Push-button to mute the audio in all outputs. The word MUTE will appear on the Front Panel Display. To un-mute the audio, press the MUTE Push-button again.

### Disc Players

Use these push-buttons to operate a DVD Player, CD Player, CD Changer or Music Server.





### Numbered Push-buttons

Press Push-buttons 0 through 9 to access tuner station presets, tracks on discs or selections on a Music Server.



### Disc and Track

Use the AM (disc) and FM (track) Push-buttons when a Disc Player or Music Server is being used.

### Tuner Push-buttons

Press the AM or FM Push-button to select the desired broadcast band. Press and release the Seek Up  the band or Seek Down  the band Push-button to seek the next available station. Press and hold a Directional Up  or Down  Push-button to tune continuously from station to station.



### Volume

Press the VOLUME Up  or Down  Push-button to raise or lower the listening volume level.

### Pause

Press the Pause  Push-button to perform various functions on a variety of McIntosh Components. It will also pause the playing of a disc or tape player.

### Trim

Press the TRIM Push-button until the desired Trim function (Balance, Trim Level, etc.) appears on the Front Panel Display, then press the LEVEL Up  or Down  Push-button to adjust the Trim setting.

*Note: Press the TRIM Push-button to recall the last Trim function selected. For additional information on the Trim Functions refer to page 22 thru 25.*





INPUT Control allows the selection of various sources for listening and recording.

TRIM allows selection of various types of audio settings. It is also used in the setup mode for various functions

LED indicates when the Left Channel Amplifier POWER GUARD circuit activates

LED indicates when the Right Channel Amplifier POWER GUARD circuit activates

VOLUME Control allows adjustment of the listening level for both channels.

ADJUST is also used in the setup mode for various functions

Meter indicates the Left Channel Output of the amplifier

Meter indicates the Right Channel Output of the amplifier

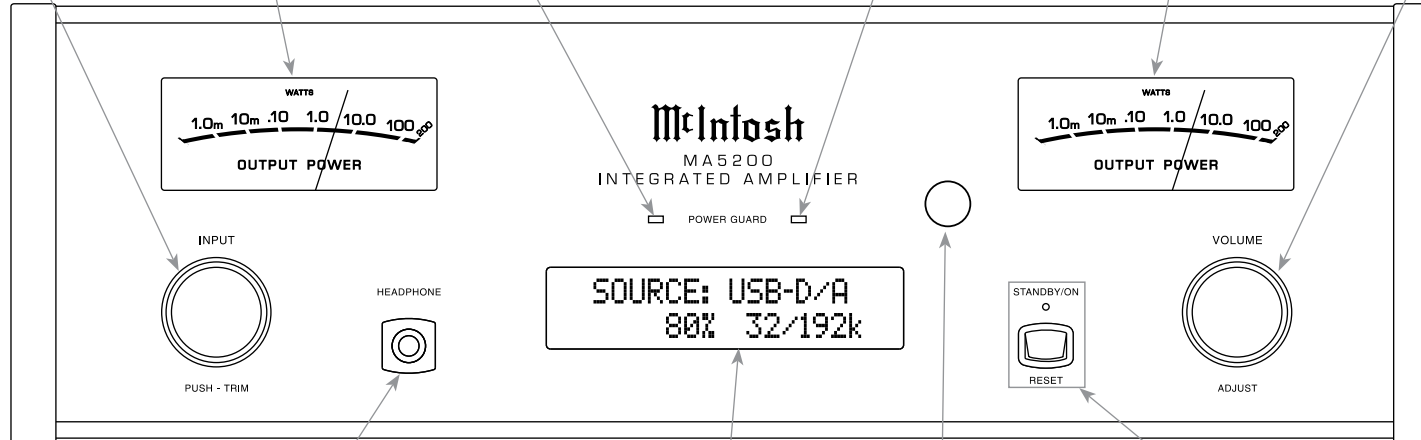

Connection for dynamic type headphones, for private listening

IR Sensor receives commands from a Remote Control

STANDBY/ON Push-button with indicator switches the MA5200 ON or OFF (Standby) and resets the microprocessors

INFORMATION DISPLAY indicates the Sources, Volume, other Audio Settings, Operational Functions and Setup Mode Settings



## How to Operate the Setup Mode

Your McIntosh MA5200 has been factory configured for default operating settings that will allow immediate enjoyment of superb audio without the need for further adjustments. If you wish to make changes to the factory default settings, a Setup Feature is provided to customize the operating settings using the Front Panel Display. Refer to the MA5200 Front Panel Illustration on the previous page while performing an introduction into operating the Setup Mode, follow the steps below.

*Note: If the MA5200 is currently On, proceed to step 2.*

1. Press the STANDBY/ON Push-button on the Front Panel or press the  (Power) Push-button on the Remote Control to switch On the MA5200. The MA5200 will go through a brief startup initialization with the Front Panel Display indicating the last used source and volume setting. This is followed by the volume setting indication starting at zero and then increasing to the last used volume setting. Refer to figure 1.



Figure 1

2. Press and hold the INPUT CONTROL until the Front Panel Display indicates “MA5200 V\_.\_, S/N: \_\_\_\_\_”. The information indicated on the Front Panel Display includes the Model Number, Firmware Version and the Serial Number for this unit; see page 18 for additional information. Refer to figure 2.



Figure 2

3. Now rotate the INPUT CONTROL Clockwise until the Front Panel Display indicates “McIntosh USB AUDIO, V\_.\_ Firmware”. Refer to figure 3 and to page 18 for additional information.



Figure 3

4. Next, rotate the INPUT CONTROL Clockwise again until the Front Panel Display indicates “SETUP: SOURCE INPUT, CD :RCA” Refer to figure 4.



Figure 4

5. To exit from the Setup Mode, press the INPUT CONTROL and the Front Panel Display will revert back to its normal display. Refer to figure 1.

## Default Settings

The Default Settings Chart below indicates the Function Name, Default Setting and the Page Number for additional information.

Default Settings		
Function Name	Setting	Page No.
MA5200	V_._ S/N: _____	18
McIntosh USB Audio	V_._	18
SOURCE INPUT (Reassignment)	RCA	18
SOURCE NAME (Re-assign Input Names)	_____ >> _____	19
PASSTHRU	OFF	20
COMM PORT (Baud Rate)	115200	21
REMOTE (Codes)	NORM	22
POWER MODE (Auto Off)	ENABLED	22

*Note: Setup Mode operations should be performed in the order they appear in the Setup Menu as they are interactive.*



## Firmware Version

The MA5200 functionality is controlled by internal software that is known as Firmware. The MA5200 has two different Firmwares, one is the “System Firmware” (responsible for the basic operation of the MA5200) and the other known as USB Audio Firmware (responsible for the “USB Connection and Conversion” of a Digital Audio Signal from the Computer). The Version of the Firmwares in the MA5200 can be identified at any time by utilizing the Setup Mode.

1. Press and hold the INPUT CONTROL until the Front Panel Display indicates “MA5200 (or MA5200) V\_.\_, S/N: \_\_\_\_\_”. The number after the “V” is the firmware version and the number after the “S/N” is the serial number of the unit (or higher). Refer to figure 2.



Figure 2

2. The number after the character “V” is the Firmware number.
3. Rotate the INPUT CONTROL Clockwise until the Front Panel Display indicates “McIntosh USB AUDIO MA5200, V2.10 or higher USB Audio Firmware”. Refer to figure 3.



Figure 3

4. To exit from the Setup Mode, press the INPUT CONTROL and the Front Panel Display will revert back to its normal display.

## Source Input Reassignment

The MA5200 provides the ability to reassign High Level Inputs (non-Phono) to either the Balanced Input or one of the two Digital Inputs.

In the first example, the CD Input will be reassigned from the unbalanced CD (RCA Jacks) to the BALANCED Connectors (XRL).

- Notes:*
1. Any one of the Default Inputs may be switched Off. If any input is switched Off its name will no longer appear on the Front Panel Display when using the INPUT Control, nor is it accessible with the Remote Control.
  2. The Phono MM (Moving Magnet) Input is designed for connection of a turntable only and thus non-reassignable, however the Phono Input may be switched Off.
  3. Only one Input may be assigned at a time to the Balanced or Digital (1 or 2) Connectors. If an already assigned Balanced or Digital connector is to be reassigned to a different Input, the Input currently assigned to the connector first needs to be changed. It can be temporarily set to Off, RCA connector, available Balanced or available Digital connector.

1. Press and hold the INPUT CONTROL until the Front Panel Display indicates the Setup Mode is active. Then rotate the INPUT CONTROL and select the Setup Menu item “SETUP: SOURCE INPUT, CD :RCA”. Refer to figure 4.

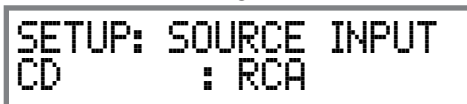

Figure 4

2. Rotate the VOLUME Control until “SETUP: SOURCE INPUT, CD :BALANCED” appears on the Front Panel Display. Refer to figure 5.



Figure 5

The second example will illustrate reassigning the CD2 Input (connected to a SACD/CD Player) from CD2 Input (RCA Jacks) to the DIGITAL 1 Optical Input.

3. Press the VOLUME Control and the CD Input will change to the CD2 INPUT. The Front Panel Display will now indicate “SETUP: SOURCE INPUT, CD2 :RCA”. Refer to figure 6.



Figure 6

4. Rotate the VOLUME Control until “SETUP: SOURCE INPUT, CD2 :DIGITAL 1” appears on the Front Panel Display. Refer to figure 7.



Figure 7

Record any changes made to the various inputs from the default settings in the “Input Settings” chart for future reference.

5. To exit from the Setup Mode, press the INPUT CONTROL and the Front Panel Display will revert back to its normal display.

Input Settings		
Input Name	Connection Type	New Level (Trim)
TUNER		
CD		
CD2		
AUX		
PHONO MM		

### Source Input Renaming

The MA5200 Default Input Names (CD, AUX, DVD, etc. as indicated on the Front Panel Display) can be customized with a different name up to nine characters long (My Phone, MCD1100, etc.). The available characters for renaming the input include the following: ! < > \* , / - \_ 0 1 2 3 4 5 6 7 8 9 A B C D E F G H I K L M N O P Q R S T U V W X Y Z .

In the following example, the AUX Input will be re-named to "MY-PHONE".

1. Press and hold the INPUT CONTROL until the Front Panel Display indicates the Setup Mode is active. Then rotate the INPUT CONTROL and select the Setup Menu item "SETUP: SOURCE NAME, AUX >> AUX". Refer to figure 8.



Figure 8

*Note: If the AUX Input is not displayed, press the VOLUME Control repeatedly until it is displayed.*

2. Press and hold the VOLUME Control until the character "A" of the name AUX starts flashing. Refer to figure 9.



Figure 9

3. Rotate the VOLUME Control until the character "M" appears. Refer to figure 10.



Figure 10

4. Press the the VOLUME Control until the character "U" starts flashing. Refer to figure 11.



Figure 11

5. Rotate the VOLUME Control until the character "Y" appears. Refer to figure 12.



Figure 12

6. Repeat steps 3 thru 5 until the new name of "MY-PHONE" is indicated on the Front Panel Display. Refer to figure 13.



Figure 13

7. To save the new Input Name press and hold the VOLUME Control until the word SAVED appears momentarily on the Front Panel Display. Refer to figure 14.



Figure 14

*Note: When direct accessing the "MY-PHONE" Input using the Remote Control, press the AUX Pushbutton.*

Record any changes made to the various default Input Names in the following chart for future reference.

8. To exit from the Setup Mode, press the INPUT CONTROL and the Front Panel Display will revert back to its normal display.

Source Input Renaming	
Default Input Name	New Input Name
TUNER	
CD	
CD2	
AUX	
PHONO MM	



## Passthru

The MA5200 can be part of a Multichannel Sound System for SACD, DVD-Audio and Home Theater. The Right and Left Front Channels from an Audio/Video Control Center or Surround Decoder can “Passthru” the Preamplifier Circuitry of the MA5200, and then on to the Power Amplifier Circuitry of the MA5200. The Setup Mode allows the activation of the Passthru Mode and the selection of the specified MA5200 Input Source. In the example below, the Right and Left Front Channels from the Audio/Video Control Center will be connected to the AUX Input Jacks on the MA5200. Refer to page 10 for additional connection information.

- Notes:*
1. The Phono Input Jacks and Digital Input Connectors are not assignable as a Passthru Input.
  2. If the Balanced Input Connectors are already reassigned to a given Input, they will not appear in the list of available Inputs for the Passthru Mode.
  3. When one of the RCA Inputs is selected as a Passthru Input, it is advisable to remove it from the list of available Inputs by switching it Off. Refer to “Source Inputs Reassignment” starting on page 18.

1. Press and hold the INPUT CONTROL until the Front Panel Display indicates the Setup Mode is active. Then rotate the INPUT CONTROL and select the Setup Menu item “SETUP: PASSTHRU, Source: OFF”. Refer to figure 15A.

```

SETUP: PASSTHRU
Source: OFF
  
```

Figure 15A

2. Rotate the VOLUME Control until “SETUP: PASSTHRU, Source: AUX<RCA>” appears on the Front Panel Display. Refer to figure 15B.

```

SETUP: PASSTHRU
Source: AUX <RCA>
  
```

Figure 15B

3. To exit from the Setup Mode, press the INPUT CONTROL and the Front Panel Display will revert back to its normal display.

## Comm Port Baud Rate

The MA5200 may be remotely controlled from other equipment connected to the Rear Panel RS232C Jack. The speed at which the MA5200 communicates (8 bit, no parity and 1 stop bit) with other equipment is adjustable from 9,600 bits per second to 115,200 bits per second. To change from the default speed of 115,200 bits per second, perform the following steps:

1. Press and hold the INPUT CONTROL until the Front Panel Display indicates the Setup Mode is active. Then rotate the INPUT CONTROL until the Setup Menu item “SETUP: COMM PORT, BAUD RATE: 115200” appears on the Front Panel Display. Refer to figure 16.

```

SETUP: COMM PORT
BAUD RATE: 115200
  
```

Figure 16

2. Rotate the VOLUME Control to select the desired speed.
3. To exit from the Setup Mode, press the INPUT CONTROL and the Front Panel Display will revert back to its normal display.

## Remote Control Codes

The Remote Control included with the MA5200 utilizes the NORMAl McIntosh Control Codes. The Second Set of Control Codes the MA5200 will respond to is referred to as the ALternate Codes. When the MA5200 is used in the same location as another McIntosh Preamplifier and/or A/V Control Center, the ALternate Codes are used. This will prevent the Remote Control from affecting the operation of both units at the same time. To activate the Remote Control ALternate Codes perform the following steps:

1. Press and hold the INPUT CONTROL until the Front Panel Display indicates the Setup Mode is active. Then rotate the INPUT CONTROL until the Setup Menu item “SETUP: REMOTE, CODES: NORM” appears on the Front Panel Display. Refer to figure 17.

```

SETUP: REMOTE
CODES: NORM
  
```

Figure 17

2. Rotate the VOLUME Control to select “SETUP: REMOTE, CODES: ALT”. Refer to figure 18.

```

SETUP: REMOTE
CODES: ALT
  
```

Figure 18

3. To exit from the Setup Mode, press the INPUT CONTROL and the Front Panel Display will revert back to its normal display.
4. To change the MA5200 Remote Control to the Alternate Codes perform the following steps:
  - A. Press the “Mc” Push-button.
  - B. Press the SET Push-button until the “Mc” Push-button flashes twice.
  - C. Press the 3, 2, 4, 2 and 9 Push-buttons within 5 seconds.
  - D. The “Mc” Push-button flashes twice.

*Note: To reset the Remote Control to normal codes perform steps A and B then enter 3, 2, 4, 2 and 8 for step C.*

5. Press the VOLUME UP/DOWN Push-button on the Remote Control to verify proper operation.

## Power Mode

The MA5200 incorporates an Auto Off Feature, which automatically places the preamplifier into the Power Saving Standby/Off Mode. This occurs approximately 30 minutes after there has been an absence of audible audio signals on the selected input (on either channel) or user activity (includes changes to any of the Operation Functions such as source selection, volume adjustment, etc). If it is desirable to disable the Auto Off Feature perform the following steps:

1. Press and hold the INPUT CONTROL until the Front Panel Display indicates the Setup Mode is active. Then rotate the INPUT CONTROL until the Setup Menu item "SETUP: POWER MODE, Auto Off: Enabled" appears on the Front Panel Display. Refer to figure 19.



```
SETUP: POWER MODE
Auto Off: Enabled
```

Figure 19

2. Rotate the VOLUME Control until "SETUP: POWER MODE, Auto Off: Disabled" appears on the Front Panel Display. Refer to figure 20.



```
SETUP: POWER MODE
Auto Off: Disabled
```

Figure 20

3. To exit from the Setup Mode, press the INPUT CONTROL and the Front Panel Display will revert back to its normal display.

## How to Operate the MA5200

### Power On and Off

The Red LED above the STANDBY/ON Push-button lights to indicate the MA5200 is in Standby mode. To switch ON the MA5200, press the STANDBY/ON Push-button on the Front Panel or press the (Power) Push-button on the Remote Control. The MA5200 will go through a brief startup initialization with the Front Panel Display indicating Power Guard is active, last used source and volume setting. This is followed by the volume setting indication starting at zero and then increasing to the last used volume setting. Refer to figures 50, 51, 52 and 53. To switch OFF the MA5200, press the STANDBY/ON Push-button on the Front Panel or the OFF Push-button on the Remote Control.

*Note: For an explanation of the Remote Control Push-button functions, refer to pages 14 and 15.*



Figure 51

### Source Selection

Rotate the INPUT Control to select the desired source or press the appropriate push-button on the Remote

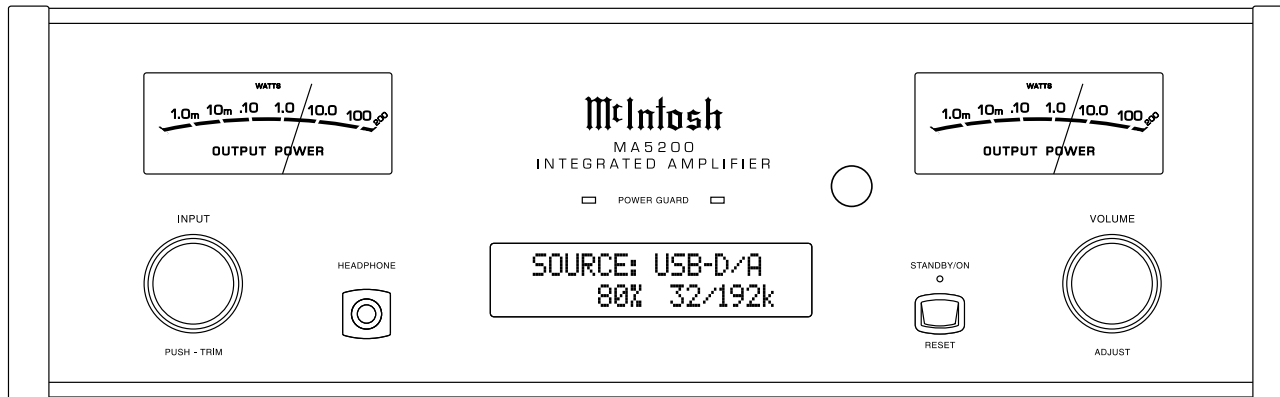

Figure 50

Control. Refer to figures 50 and 53.



Figure 52

### Volume Control

Rotate the Front Panel VOLUME Control or use the VOLUME Up (+) or Down (-) Push-buttons on the Remote Control for the desired listening level. Refer to figures 50 and 53.

### Trim Functions

The MA5200 has various Trim Selections with Adjustments. The Trim Functions include Balance, Trim Level, Output Mode, Mono/Stereo, Display Brightness, Digital Audio and Meter Backlight. The Trim Settings are stored in memory independently for each Input Source Selected, except the Meter Illumination and Digital Audio Display settings of On or Off, which are the same for all inputs.

The selection and adjustment of all Trim Functions may be performed by first pressing the Front Panel INPUT/TRIM Control. Then rotate the INPUT/TRIM Control to select the desired Trim Function. This

is followed by rotating the VOLUME/ADJUST Control to make a change/adjustment in the Trim Setting.

The Remote Control TRIM Push-Button together with the LEVEL + / - Push-button may also be used. Refer to figures 50 and 53.

After approximately 5 seconds the Display returns to indicate the Source Selection and Volume Level.

### BALANCE

Listening balance varies with different program sources, room acoustics and listening positions relative to the Loudspeakers. Use the Balance (Trim Function) as needed to achieve approximately equal listening volume levels in each Loudspeaker. To adjust the Balance perform the following:

1. Press the TRIM Push-button repeatedly on the Remote Control until “BALANCE 0 dB” appears on the Front Panel Display. Refer to figure 54.  
*Note: The Front Panel INPUT/TRIM Control may also be used.*
2. Rotate the VOLUME Control or press the LEVEL + / - Push-buttons on the Remote Control to em-

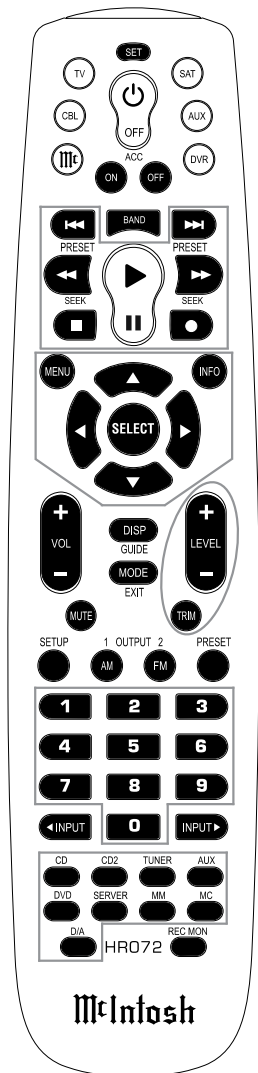

Figure 53



Figure 54

phasize the Right Channel (refer to figure 55) or the Left Channel (refer to figure 56).



Figure 55



Figure 56

The Front Panel Display indicates the Balance changes in steps from 0 to 50dB. After approximately 5 seconds, the Display returns to indicate the Source Selection and Volume Level. To verify the Balance setting without changing it, use the TRIM Push-button and select Balance.

TRIM LEVEL

Source Components can have slightly different volume levels resulting in the need to readjust the MA5200 Volume Control when switching between different sources. The MA5200 allows the adjustment of levels for each of the Source Inputs for the desired same relative volume. The TUNER and CD Inputs are used in the following example.

*Note: The range of adjustment is ± 6dB. The level adjustments made are retained in permanent memory. They can be changed during operation of the MA5200 by performing a Trim Level Procedure.*

1. Press the TUNER Push-button on the Remote Control and press the VOLUME Push-button +/- for the desired listening level.

2. Repeatedly press the TRIM Push-button on the Remote Control until “TRIM LEVEL: 0.0dB, Min Max” appears on the Front Panel Display. Refer to figure 57.

*Note: The TUNER Input is serving as a reference level or choose another source frequently listened to. The Input Source should be set to a reference Level (Trim) of 0.0dB.*



Figure 57

3. Press the CD Push-button on the Remote Control and note if the relative volume is louder or quieter than the volume level of the TUNER.
4. Repeatedly press the TRIM Push-button on the Remote Control until “TRIM LEVEL: 0.0dB, Min Max” appears on the Front Panel Display. Refer to figure 57.
5. Press the TRIM LEVEL +/- Push-button on the Remote Control to achieve the same relative volume as the TUNER Input. In our example the relative volume level of the CD Input is louder than the TUNER Input, so the trim level for the Server Input is reduced to -2.5 dB. Refer to figure 58.



Figure 58

6. Repeat steps 1 thru 4 until the relative volume is the same between the TUNER and CD Inputs.
7. Repeat the above steps for the remaining inputs with component sources connected until they all have the same relative volume levels. Record any changes made to the various inputs from the

default settings in the “Input and Power Control Settings” chart on page 19.

After approximately 5 seconds the Display returns to indicate the Source Selection and Volume Level.

OUTPUT MODE

The OUTPUT MODE default setting for the MA5200 is On. The Power Amplifier Output is then available at the R&L Output Terminals to drive the connected Loudspeakers. When it is desirable to switch the Loudspeakers Off (eg. during listening with headphones) set the OUPUT MODE to Off. To switch the Loudspeaker Off, perform the following steps:

1. Press the TRIM Push-button on the Remote Control until “OUTPUT MODE, Speaker: On” appears on the Front Panel Display. Refer to figure 59.



Figure 59

2. Press TRIM LEVEL +/- Push-button to select the Off Mode. Refer to figure 60.



Figure 60

After approximately 5 seconds the Display returns to indicate the Source Selection and Volume Level.

MONO/STEREO MODE

By default the Stereo Mode is active for all Input Sources however, any Input Source may be assigned to Mono Mode. To change Stereo Mode to Mono for a given Input Source, perform the following steps:



## How to Operate the MA5200, con't

1. Select the desired Input by using the direct access Input Push-button on the Remote Control.
2. Press the TRIM Push-button on the Remote Control until “MONO/STEREO MODE, \_\_\_\_\_ : Stereo” appears on the Front Panel Display. Refer to figure 61.



Figure 61

3. Press TRIM LEVEL +/- Push-button to select the MONO Mode. Refer to figure 62.



Figure 62

After approximately 5 seconds the Display returns to indicate the Source Selection and Volume Level.

### DISPLAY BRIGHTNESS

The Front Panel Display Brightness may be changed from the default setting. The MA5200 will remember two brightness preferences, one with the Meters Illuminated and one without Meter Illumination. For

each preference there are four brightness settings for the Display. The Display Brightness setting may be varied 1 (Dim) to 4 (Bright). Follow the steps below for reducing the Display Brightness (with the Meter Illumination On):

1. Press the TRIM Push-button on the Remote Control until “DISPLAY, Brightness: 3” appears on the Front Panel Display. Refer to figure 63.



Figure 63

2. Press TRIM LEVEL +/- Push-button to select the desired Brightness.

*Note: To change the Display Brightness preference with Meter Backlight Off, first switch Off the Meter Backlight on this page and then change the Display Brightness Setting.*

After approximately 5 seconds the Display returns to indicate the Source Selection and Volume Level.

### DIGITAL AUDIO DISPLAY

By default the Digital Audio Display is switched Off. To display information about the type of digital signal

present when any one of the three digital inputs is selected, perform the following steps:

1. Select one of the Inputs assigned to an active digital source.

*Note: The USB-D/A Input may also be selected when the MA5200 is connected to a computer.*

2. Press the TRIM Push-button on the Remote Control until “DIGITAL AUDIO, Display Info: On” is indicated on the Front Panel Display. Refer to figure 64.



Figure 64

3. If it is not desirable to display the information, use the TRIM LEVEL +/- Push-button to switch it Off. Refer to figure 65.



Figure 65

After approximately 5 seconds the Display will return to indicate the Source Selection and Volume Level.

### METER BACKLIGHT

The MA5200 Front Panel Meter Illumination may be switched On or Off by performing the following:

1. Press the TRIM Push-button on the Remote Control until “METER BACKLIGHT, Lights: On” appears on the Front Panel Display. Refer to figure 66.



Figure 66

2. Press TRIM LEVEL +/- Push-button to switch Off the Meter Illumination. Refer to figure 67.

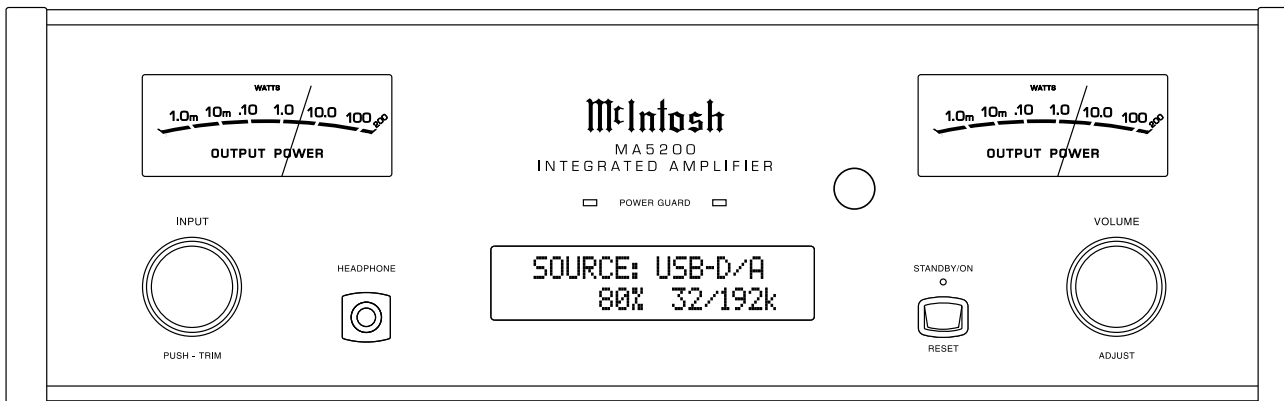

Figure 50



METER BACKLIGHT  
Lights: Off

Figure 67

After approximately 5 seconds the Display returns to indicate the Source Selection and Volume Level.

- Notes: 1. For information on how the Front Panel Display Brightness can change with the Meter Illumination On/Off Setting, refer to page 24 "Display Brightness".
2. Meter Illumination of recent McIntosh Power Amplifiers will also switch On/Off when connected to the MA5200 via a power control cable.

**Trim**

Press the Front Panel INPUT/TRIM Control to activate the MA5200 Trim Functions. Rotate the Front Panel INPUT/TRIM Control to select the desired Trim Function and then rotate the VOLUME/ADJUST Control to vary or make changes. Refer to figure 50. The Remote Control TRIM and LEVEL +/- Push-buttons may also be used. Approximately 5 seconds after Trim Function Selection and/or adjustments have stopped, the MA5200 will switch off the Trim Mode.

**Mute**

Press the MUTE Push-button on the Remote Control to Mute the Audio in the Loudspeakers, PRE AMP Output Jacks and the Headphones. The Front Panel Display will indicate the Source Name and with the word MUTE in place of the actual volume setting. Refer to figure 68.

SOURCE: CD  
MUTE

Figure 68

Pressing the Mute Push-button a second time or ad-

justing the volume control will un-mute the MA5200.

**Headphones Jack**

Connect a pair of dynamic headphones to the Headphones Jack with a 1/4" (6.4mm) stereo phone type plug for private listening. Use the TRIM Output Mode to mute the Loudspeakers. Refer to figure 50 and "OUTPUT MODE" on page 23.

Note: The Headphone Output is optimized for impedances ranging from 20 to 600 ohms.

**Power Output Meters**

The MA5200 Power Output Meters indicate the power delivered to the Loudspeakers. Refer to figure 69.

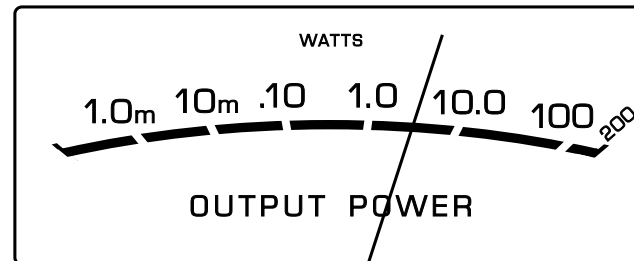

Figure 69

The meters respond to all the musical information being produced by the Amplifier. They indicate to an accuracy of at least 95% of the power output with only a single cycle of a 2,000Hz tone burst.

**Power Guard**

During normal operation, the Front Panel Power Guard Indicators will momentarily illuminate during peaks in the audio signals. In the event the MA5200 over heats, due to improper ventilation, high ambient temperature and/or impedance mismatch, the internal protection circuits will activate. The Front Panel Power Guard Indicators will continuously illuminate

and the audio will be muted. When the MA5200 has returned to a safe operating temperature, normal operation will resume.

**Using a Separate Power Amplifier**

To use a separate amplifier instead of the MA5200 built-in Power Amplifier, connect the Loudspeakers to the separate power amplifier and remove the McIntosh Jumpers that are located between the PRE AMP OUTPUTS Jacks and the PWR AMP INPUT Jacks. Connect an audio cable between the separate Power Amplifier input jacks and the PRE AMP OUTPUTS Jacks on the MA5200. Refer to figures 70 and 71.

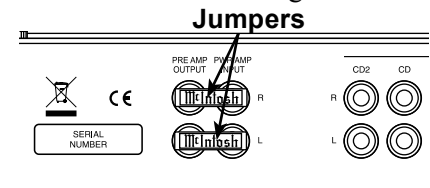

Figure 70

**To Separate Power Amplifier**

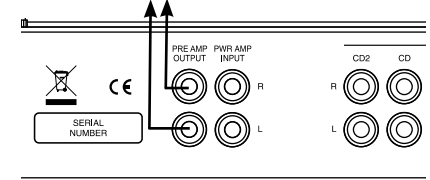

Figure 71

Note: The Output Power Meters on the Front Panel of the MA5200 will no longer indicate Power Output. Refer to Power Output Indicators on the connected separate Power Amplifier instead.

**Passthru**

When the MA5200 is connected together with a McIntosh Multichannel A/V Control Center or Surround



## How to Operate the MA5200, con't

Decoder and has the PASSTHRU Mode activated, it will automatically switch On when the A/V Control Center or Surround Decoder is switched On. It will indicate on the Front Panel Display “PASSTHRU”. Refer to figure 72.



Figure 72

The other Front Panel Controls are deactivated as long as the Passthru Mode is active.

## Optical and Coaxial Digital Inputs

When a Digital Input (Optical or Coaxial Connection) on the MA5200 is selected the Front Panel Display will indicate when a signal is present “2CH PCM”. Refer to figure 73. During the time there is no Digital



Figure 73

Signal present the display will indicate “SILENT”. Refer to figure 74.



Figure 74

## USB Input Operation with a Computer

The MA5200 USB-D/A Input provides the capability to playback music from a computer, when the computer is connected to the rear panel USB D/A connector. The MA5200 USB Input is compatible with both PC Computers using Microsoft® Windows® (XP with Service Pack 3, Vista with Service Pack 1 and Windows 7) and the Apple® Macintosh® Computers using OS-10.6 with the latest update.

When using a PC Computer with Windows, a special McIntosh USB Audio Software Driver needs to be installed on the PC Computer. The driver needs to be installed before connecting the MA5200 USB Input to an USB Port on the computer.

*Note: If an Apple Macintosh computer is used with the MA5200, no additional driver is required.*

The McIntosh USB Audio Windows Driver and Installation and Operation Guide are available for download from the McIntosh Web Site:

<http://www.mcintosh-labs.com/us/support/Pages/Manuals.aspx>

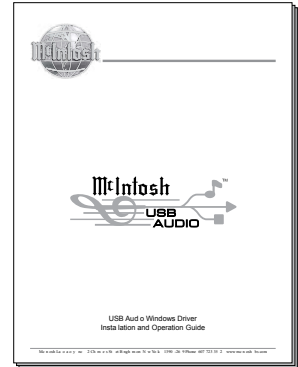

Under “Product Category” select Preamplifiers and under “Model Number” select MA5200, then click on “Select”. When the MA5200 information appears, download the “McIntosh Audio Windows Driver Installation and Operation Guide” and “McIntosh USB Audio Windows Driver V\_ . \_”. Follow the instructions in the Guide and after the USB Driver is installed, connect the MA5200 to the PC Computer.

*Note: When computer application programs and various computer hardware components conform to the Microsoft® Windows® and Apple® Macintosh® standards, they should also work well when used in conjunction with the MA5200 USB Input. If you are experiencing difficulty with a specific computer hardware component or computer application program, contact the manufacturer of the product.*

The MA5200 Front Panel Display will indicate the Bit and Sampling Rate of the incoming digital signal. Refer to figure 75.



Figure 75

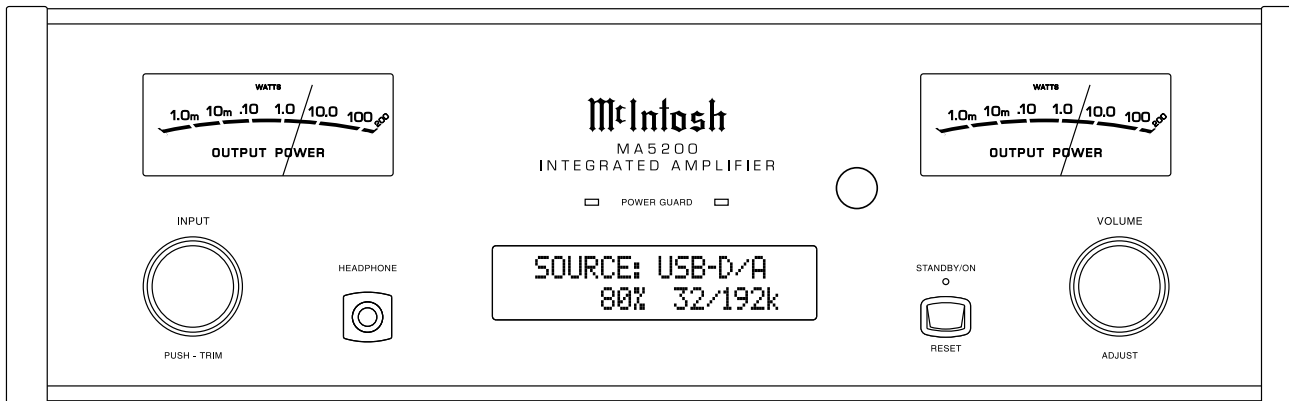

Figure 50

## Reset of Microprocessors

In the unlikely event the controls of the MA5200 stop functioning, the microprocessors can be reset by

performing the following:

1. Press the STANDBY/ON Push-button until the STANDBY/ON Indicator switches Off.
2. When the MA5200 cycles On then Off, release the STANDBY/ON Push-button.
3. When the STANDBY/ON LED is illuminated press the STANDBY/ON Push-button, the MA5200 will resume normal operation.

*Note: This can be performed with the MA5200 On or in the Standby Mode.*

### Resetting the MA5200 to default settings

If it becomes desirable to reset all the adjustable settings (Setup and Trim Settings) to the factory default values, perform the following:

1. Press in and hold the INPUT/TRIM Control and the VOLUME/ADJUST Control. The Front Panel Display will indicate "FACTORY RESET". Refer to figure 76.



Figure 76

2. When the Front Panel Display indicates "FACTORY RESET, COMPLETE" release the two controls. Refer to figure 77.



Figure 77

3. Press the STANDBY/ON Push-button and the MA5200 will resume operation.









## Amplifier Specifications

### Power Output

100 watts is the minimum sine wave continuous average power output per channel, both channels operating

### Output Load Impedance

8 ohms

### Rated Power Band

20Hz to 20,000Hz

### Total Harmonic Distortion

0.005% maximum with both channels operating from 250 milliwatts to rated power, 20Hz to 20,000Hz

### Dynamic Headroom

1.8dB

### Frequency Response

+0, -0.5dB from 20Hz to 20,000Hz

+0, -3dB from 10Hz to 100,000Hz

### Preamplifier Output (for rated input)

1V (8V Maximun)

### Sensitivity (for rated output)

High Level, 250mV unbalanced, 500mV balanced

Phono MM, 2.5mV

Power Amp In, 1V

### Signal To Noise Ratio (A-Weighted)

High Level, 95dB below rated output

Phono MM, 82dB below 5mV input

Power Amplifier, 110dB below rated output

### Intermodulation Distortion

0.005% maximum, if the instantaneous peak power is 200 watts or less per channel with both channels operating for any combination of frequencies from 20Hz to 20,000Hz

### Wide Band Damping Factor

Greater than 200

### Input Impedance

High Level, 20K ohms

Phono MM, 47K ohms; 50pF

Power Amp In, 10K ohms

### Maximum Input Signal

High Level, 8V unbalanced, 16V balanced

Phono MM, 80mV

Power Amplifier In, 8V

### Preamplifier Output Impedance

220 ohms

### Headphone Impedance

20 to 600 ohms

### Power Guard

Less than 2% THD with up to 16dB overdrive at 1,000Hz

### Voltage Gain

High Level to Preamp: 12dB

Phono MM to Preamp: 52dB

Power Amplifier: 29dB

### Digital Input Sample Rates

Optical: 16Bit, 24Bit - 32kHz to 96kHz

Coaxial: 16Bit, 24Bit - 32kHz to 96kHz

USB: 16Bit, 24Bit, 32Bit - 32kHz to 192kHz

### Power Control Output

12VDC, 25mA

## General Specifications

### Power Requirements

*Field AC Voltage conversion of the MA5200 is not possible. The MA5200 is factory configured for one of the following AC Voltages:*

100 Volts, 50/60Hz at 2.7 amps

110 Volts, 50/60Hz at 2.3 amps

120 Volts, 50/60Hz at 2.3 amps

220 Volts, 50/60Hz at 1.3 amps

230 Volts, 50/60Hz at 1.2 amps

240 Volts, 50/60Hz at 1.2 amps

Standby: Less than 0.25 watt

*Note: Refer to the rear panel of the MA5200 for the correct voltage.*

### Overall Dimensions

Width is 17-1/2 inches (44.5cm)

Height is 6 inches (15.2cm) including feet

Depth is 22 inches (55.9cm) including the Front Panel, Knobs and Cables

### Weight

38 pounds (17.2 kg) net, 55.5 pounds (25.2 kg) in shipping carton

### Shipping Carton Dimensions

Width is 26-1/2 inches (67.3cm)

Depth is 24-1/4 inches (62.2cm)

Height is 11-3/4 inches (29.9cm)

**Packing Instructions**

In the event it is necessary to repack the equipment for shipment, the equipment must be packed exactly as shown below. It is very important that the four plastic feet are attached to the bottom of the equipment. Two #10 x 2-1/2 inch screws and washers must be used to fasten the unit securely to the bottom pad and wood skid. This will ensure the proper equipment location on the bottom pad. Failure to do this will result in shipping damage. Use the original shipping carton and interior parts only if they are all in good serviceable condition. If a shipping carton or any of the interior part(s) are needed, please call or write Customer Service Department of McIntosh Laboratory. Refer to page 3. Please see the Part List for the correct part numbers.

**MA5200 Packing Material List**

Quantity	Part Number	Description
1	033838	Shipping carton
4	033887	End Cap
1	033836	Inner carton
1	033725	Top pad
1	034301	Bottom pad
1	034480	Wood skid
2	017218	Plastic foot (spacer)
2	401204	#10 x 2-1/2 inch wood screw
2	404033	#10 flat washer 1-3/4 inch
4	017937	Plastic foot
4	400159	#10-32 x 3/4 machine screw
2	404033	#10 flat washer

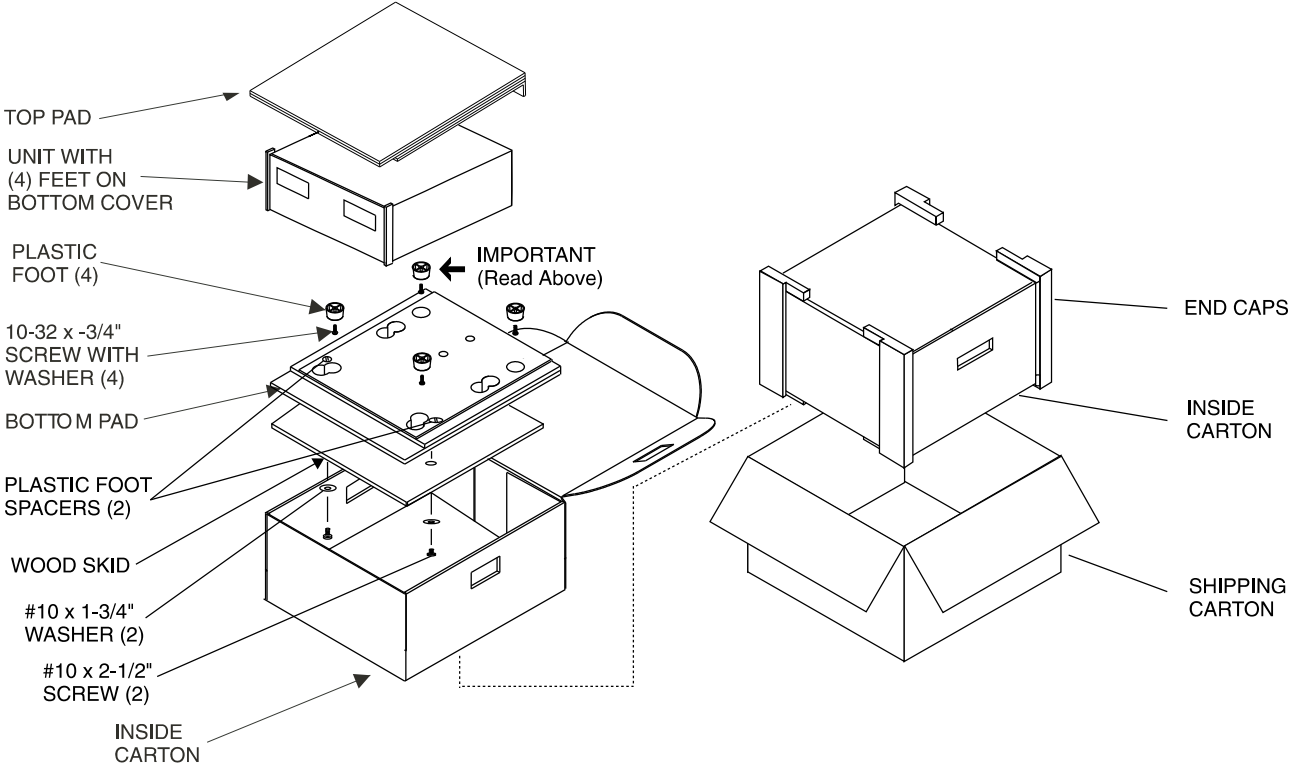



McIntosh Laboratory, Inc.  
2 Chambers Street  
Binghamton, NY 13903  
[www.mcintoshlabs.com](http://www.mcintoshlabs.com)

The continuous improvement of its products is the policy of McIntosh Laboratory Incorporated who reserve the right to improve design without notice.  
Printed in the U.S.A.